

User Manual



# Personal Locator Device

(Incorporating AIS and DSC)

English



© 2018 Ocean Signal Ltd

The technical data, information and illustrations contained in this manual were believed to be correct at the time of print. Ocean Signal Ltd reserve the right to change specifications and other information contained in this manual as part of our continual improvement process.

No part of this manual may be reproduced, stored in a retrieval system or transmitted in any form, electronic or otherwise, without the prior and express written permission of Ocean Signal Ltd.

No liability can be accepted for any inaccuracies or omissions in this manual.

Ocean Signal® and rescueME® are registered trademarks of Ocean Signal Ltd.

## IN CASE OF EMERGENCY



### Use only in situations of grave or imminent danger



If the MOB1 is correctly fitted to the life jacket, then the MOB1 will automatically activate when the life jacket inflates. This guide shows how to manually activate the MOB1.

- Slide the red Arming Tab down (1)



- Slide the grey Activation Slide (2) sideways by pulling on the attached tape and remove. This will release the antenna and activate the MOB1



Keep the MOB1 well away from your eyes when activating

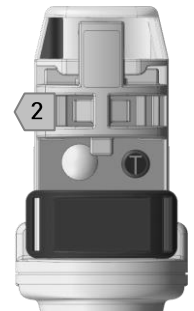

- If the strobe light does not start flashing, manually switch the MOB1 on by pressing the ON Key (3)

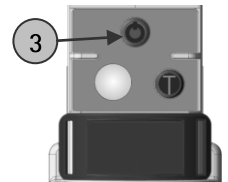

- Always turn off the MOB1 immediately after you have been rescued to avoid interference with other users. Refer to section 5.4 for deactivation instructions.

## CONTENTS

IN CASE OF EMERGENCY.....	3
1. GENERAL.....	5
1.1 Introduction.....	5
1.2 Exposure to RF Electromagnetic Energy.....	5
1.3 Warnings.....	5
2. MOB1 OVERVIEW.....	6
3. LIFE JACKET INSTALLATION.....	7
4. MMSI CONFIGURATION .....	9
4.1 Self Identification .....	9
4.2 User MMSI.....	9
5. OPERATION .....	11
5.1 Automatic Activation .....	11
5.2 Manual Activation.....	11
5.3 DSC All Ship Distress Alert transmission.....	12
5.4 Deactivation.....	12
5.5 Rewinding the antenna.....	12
5.6 False Alerts .....	12
5.7 MOB message reception.....	12
6. TESTING .....	13
6.1 Functional test.....	13
6.2 DSC Transmission Test.....	14
6.3 AIS transmission test.....	14
7. APPENDIX.....	15
7.1 Maintenance and Troubleshooting.....	15
7.2 Batteries.....	15
7.3 Transport.....	15
7.4 Disposal.....	15
7.5 Licensing (US only).....	15
7.6 Specifications.....	16
7.7 Approvals.....	17
7.8 Country of Intended Use.....	17
7.9 Limited Warranty.....	18

# 1. GENERAL

## 1.1 Introduction





The rescueME range of products provides the user with the latest technology specifically designed for compact size and ease of operation. The MOB1 is intended to alert your vessel in the event that you fall overboard. It will then plot your location on a suitable AIS equipped chart plotter.

## 1.2 Exposure to RF Electromagnetic Energy

This product also complies with EN62479 (EU) and RSS-102 (Canada).

This product has been evaluated for compliance with the FCC RF exposure limits given in CFR 47 part 1.307(b) at a distance of greater than 5cms.

## 1.3 Warnings

- 
 A Man Over Board AIS transmitter is only intended for short range signalling to an AIS receiver installed onboard your own vessel. It will not directly alert the emergency services or any other vessels.
- 
 This equipment is intended for emergency use only and it should not be used for routine tracking of persons or property, including routine tracking of divers.
- 
 If self-test is performed more frequently than once a month, then battery life may be reduced.
- 
 This radio device is designed to only provide an effective alerting and locating capability in close proximity to a vessel. This radio beacon is NOT an EPIRB.
- 
 DSC functionality may vary or be disabled according to individual countries regulations. Older DSC radios may not respond to the individual relay call.

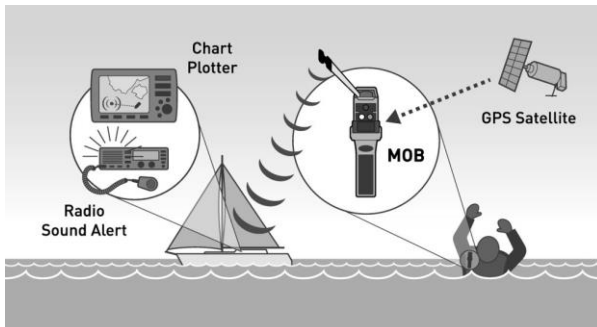

Interface diagram showing typical usage

## 2. MOB1 OVERVIEW

- 1) Antenna behind activation slide
- 2) Activation Slide
- 3) Arming Slide (shown in safe position)
- 4) ON Key (for manual activation)
- 5) Strobe and Indicator LED
- 6) TEST/OFF Key
- 7) Arming Slide (in armed position)
- 8) Activation Tape
- 9) Mounting Bracket
- 10) Antenna Rewind Tool
- 11) Programming Adaptor
- 12) Protective Cover
- 13) Length of cord to tether the MOB1 (not shown)

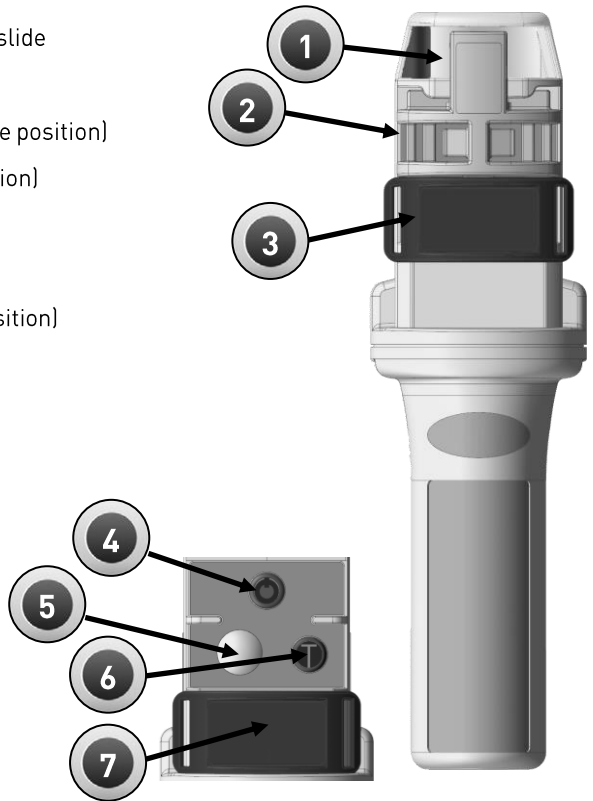

MOB1 Controls shown  
in activated condition

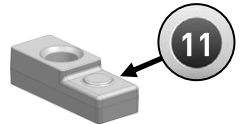
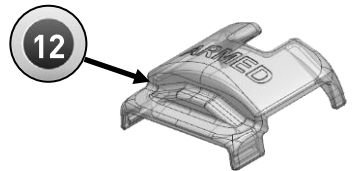
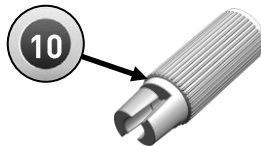
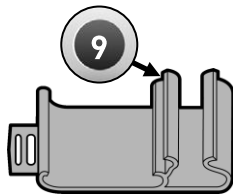
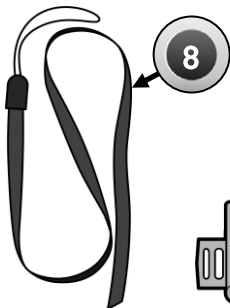

### 3. LIFE JACKET INSTALLATION

If your rescueME MOB1 is not already pre-installed into the lifejacket, please follow the instructions below carefully. The diagrams below assume that the life jacket inflation tube is on the left hand side (as viewed). If the tube is on the right hand side then the tape should be fitted on the opposite sides shown.

- Slide the red arming tab down. Carefully move the grey slide to just expose the slot. Do not move it too far otherwise the antenna will be released.

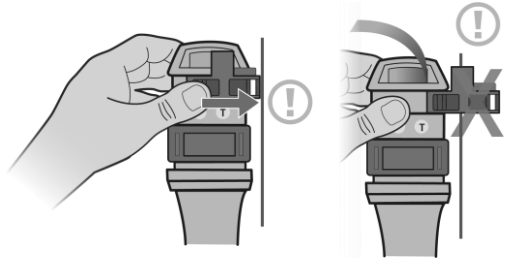

- Pass the loop of the strap through the slot in the activation clip and pass the tape back through the loop. Return the activation slide to the centre and move the red arming tab back to lock the slide in place.

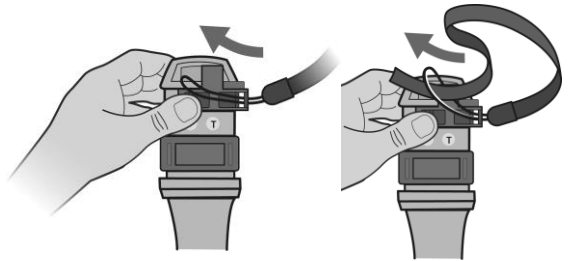

- Take the bracket and pass the tape through the slots as shown below, making sure that tape does not get twisted.

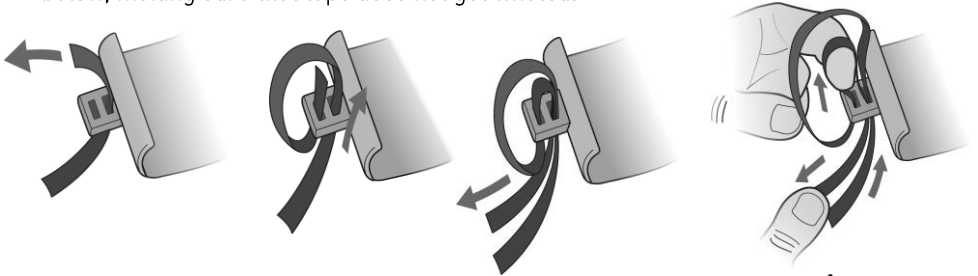

- On completion, the tape should now be connected to the bracket and MOB1 as shown.
- Pass the tape around the bladder of the life jacket and clip the bracket to the MOB1 so that the MOB1 will be on the outside of the inflation tube as shown.

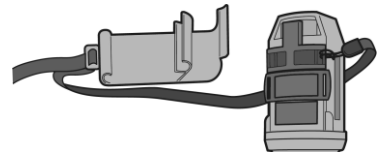

-  The MOB1 should be mounted as near to the base of the oral tube as possible and so that the tape passes over a near parallel section of the bladder.

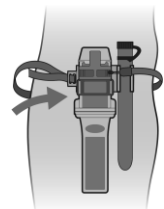

- Pull the tape tight with the free end of the tape, so that the bladder is free to inflate and remains folded in accordance with the life jacket manufacturer's instructions. Do not over tighten the tape.
- Test for tightness by ensuring you can freely insert a finger in between the tape and the bladder.
- Once the MOB1 is fully attached to the life-jacket, you are ready to arm the device, by sliding the red arming tab down.
- **Failure to arm the MOB1 will inhibit the auto activation of the MOB1 when needed and will STOP the life jacket inflating correctly.**
- If the MOB1 has turned on during the installation process, make sure it is turned off by pressing and holding the TEST/OFF Key until the LED flashes red twice and release.

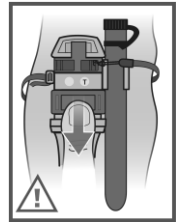
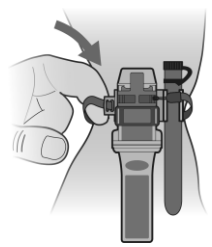

- A protective cover is provided to protect the MOB1 from accidental activation if the grey slide is knocked or otherwise moved under the life jacket cover. After mounting the MOB1, fit the protective cover, ensure the red arming slide is in the Armed position, then clip the protective cover into the slots immediately adjacent to the arming slide. Make sure that both sides of the cover are clipped in place.
- To prevent accidental loss, use the provided length of cord to tether the MOB1 to a fixed point on the lifejacket. Select a secure point on the lifejacket that the cord cannot detach or untie from if the MOB1 is accidentally removed from its bracket. The MOB1 fixing point for the cord is located on the top of the unit (as indicated).

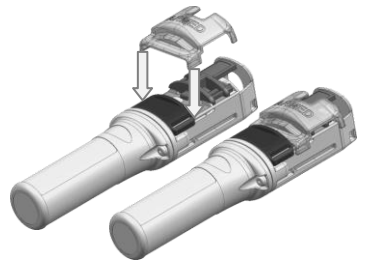

- **Ensure the MOB1 is securely tied to a fixed point on the lifejacket that will NOT inhibit inflation.**
- Repack the bladder into the cover, ensuring the bladder does not get trapped in the fastening mechanism or tangled up.
- For installation to life jackets where the bladder is permanently attached to the cover, please see the separate instruction sheet, available from the Ocean Signal website.



## 4. MMSI CONFIGURATION

If your vessel has a DSC enabled VHF radiotelephone, it is strongly recommended to programme your vessels MMSI number into your MOB1. This will allow the MOB1 to send the details of the man over board incident direct to the radio and sound the alarm.

### 4.1 Self Identification

The MOB1 is supplied with the self-identification number pre-programmed. This number is specific to each MOB1 and cannot be changed. The MMSI displayed on the DSC receiver will always start with '972' irrespective of the country it was purchased in.

### 4.2 User MMSI

(Applies to DSC enabled units only)

To be able to send DSC messages to your vessel, the MMSI number of the vessel needs to be programmed into the MOB1. This is achieved using a PC based application and its display screen.

#### 4.2.1 Installation

The programming software for configuring the User MMSI into the MOB1 can be downloaded from [www.oceansignal.com/installers](http://www.oceansignal.com/installers). The version downloaded will only allow the DSC options available in your country. Some functions described below may not be available to you.

Save the file to your computer and open it to run the installer. Follow the instructions on screen.

#### 4.2.2 Configuration

**Note: Make sure the display screen on your device display is set to full brightness before commencing programming the MOB1.**

Run the application from the desktop icon. The screen shown here will appear.

Enter the nine digit MMSI of the vessel in the box provided and select update beacon.

(In the USA, after the MMSI has been entered, a second box for a group MMSI will appear. Enter your group MMSI here if applicable, noting that group MMSI numbers should always start with a zero.)

On completion press the **Update Device** button to proceed.

A new screen with further instructions will appear.

To put the MOB1 into programming mode, slide the Arming Slide down to the armed position and press the TEST/OFF Key for at least fifteen seconds. The LED will start flashing green. Release the key.



Place the black rubber Programming Adaptor over the test key area so that the aperture is over the clear window.

When ready press the **Yes** Key on screen.

The display will now change to the programming mode. Place the MOB1 over the screen so that the clear STROBE indicator window is over the white box. Press the <F10> Key on your keyboard to commence programming.



When the programming is complete, the screen will change. Remove the MOB1 and check that the LED starts flashing green. Turn the MOB1 off by pressing the TEST/OFF Key for one second. The LED will blink red twice. Press the <F12> Key to exit the programming mode.

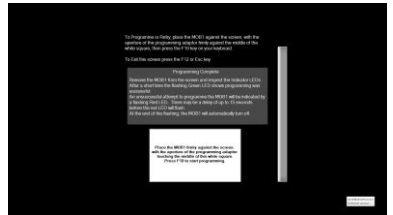

If the unit is not switched off manually, the LED will continue to flash green for several minutes and then flash red to indicate an automatic shutdown. The unit is now powered off.

If the programming fails, the LED will start flashing red after a short period of time. Turn the unit off by pressing the TEST/OFF Key and retry.

When programming is completed, return the arming tab to the locked position. Your MOB1 is now ready for fitting to the life jacket (Section 3) for use.

Alternatively, a web based application is available at [www.oceansignal.com/installers](http://www.oceansignal.com/installers) using the Launch button. This will allow the MOB1 DSC MMSI number to be configured on any device using a web browser connected to the internet. Operation is similar to the above application, but this version asks for confirmation of the MMSI number and programming will start automatically after five seconds once on the programming page.

## 5. OPERATION

**WARNING: Use only in situations of grave and imminent danger.**

**Misuse may result in a severe penalty.**



Ensure that your MOB1 is always fitted with an unused battery that is within the marked expiry date. Failure to do so may result in reduced operating time when used in a real emergency. Please observe the recommendations on testing in section 5.7.

-  To prevent accidental activation, please ensure the clear cover is fitted over the grey slider as described in Section 3 with enough free length of the activation tape so it will not pull on the slider during normal activity of the life jacket. When carrying the MOB1 please ensure the Arming Slider is in the up position.

### 5.1 Automatic Activation

When correctly packed in a lifejacket the MOB1 will automatically activate when the lifejacket inflates. Should the lifejacket fail to fully inflate, it may be necessary to assist the Activation Slide by pulling on the Activation Tape to fully release the Activation Slide.

### 5.2 Manual Activation

-  Only activate your MOB1 in situations requiring assistance ONLY in an emergency. Deliberate misuse of your MOB1 may result in a fine.
- To manually activate your MOB1 in an emergency, slide the red Arming Slide down. Slide the grey Activation Slide to the Left or Right.
-  The antenna will be automatically released. Keep the MOB1 well away from your eyes when activating.
- The strobe light will start flashing. The MOB1 will automatically start transmitting after 15seconds.
- If the MOB1 fails to activate when the slide is removed, press the ON Key down until the green LED starts flashing. Release the key.
- Upon activation, the indicator LED will show eight short flashes during AIS transmission and one long flash during DSC transmission. The colour of the flash will be Red during position acquisition and green when the GPS position is being received.
- When operating the MOB1, tether the beacon to your body or the life jacket.
- Hold your beacon with the antenna standing vertically. Keep the area marked 'Do not obstruct when armed' on the red arming slider free from obstruction, which would interfere with the GPS reception. Covering this area will interfere with the GPS reception.

### 5.3 DSC All Ship Distress Alert transmission

- ! Applies only in countries where DSC All Ships Alerts are allowed.

Press and hold the ON key for over 5 seconds to transmit a single DSC All Ships Distress Alert. This should only be done in a dire emergency if it is obvious that your alert is not being acted upon by your own vessel. Whilst the key is pressed, the green LED will start flashing then become steady. Release the key to commence transmission of a single DSC All Ships Distress Alert. The green LED will blink rapidly to indicate a DSC Distress Alert is being transmitted to ALL SHIPS.

- ! The All Ships Distress Alert will only transmit if a GPS position is obtained.

### 5.4 Deactivation

To deactivate your MOB1 after use or if it is accidentally activated, press the TEST/OFF Key until the LED flashes red twice, then release.

### 5.5 Rewinding the antenna

To rewind the antenna after activation or transmission testing, use the small grey Antenna Rewind tool supplied in the box. Place the moulded cap of the antenna into the space (1) and pass the tool through the round hole in the top of the MOB1 and place over the antenna spring just behind the cap (2). Rotate the tool anti-clockwise until the antenna is fully wound up (3). Whilst holding the antenna in place with the tool, replace the activation slide and remove the tool (4).

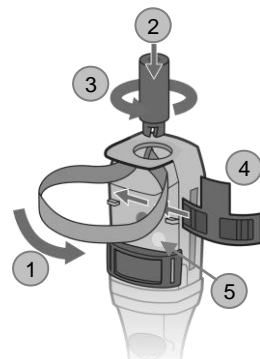

If the MOB1 has activated, turn it off by pressing the TEST/OFF Key until the LED flashes twice (5).

- ! Rotating the antenna rewind tool in the clockwise direction may result in damage to the antenna

### 5.6 False Alerts

If the MOB1 is accidentally activated, it should be immediately turned off and the nearest Coast Guard Centre or Rescue Coordination Centre should be contacted to explain that the MOB1 had been activated in error and there is no follow up rescue actions required. If appropriate make a call on the VHF radio to announce the same information.

### 5.7 MOB message reception

MOB AIS message display will depend on the reception equipment being used. AIS enabled plotters will display either as a ship or SART target with the MOB1 self-ID. The DSC will show on the radio as a distress relay call with the Self ID of the MOB1

## 6. TESTING

Routine testing of your MOB1 once a month is recommended to ensure it is in good working order if needed, but please follow the guidance notes below on the frequency that tests should be carried out. Please remember that each test will reduce the battery capacity slightly and reduce the operation time of your MOB1 during an emergency.

### 6.1 Functional test

To test your MOB1 is functioning correctly, press and hold the **TEST/OFF** Key. After one second the red LED will start flashing, indicating test mode is activated. The key may now be released. After a short pause the strobe will flash and the indicator LED will produce a flash sequence of either :

- 1 green flash; OR
- 1 to 6 amber flashes; OR
- 2 to 5 red flashes.



This flash sequence will be repeated after a short pause and then the MOB1 will automatically power off.

The flash sequence indicates the total number of hours that the battery has already been in use, up to the time that the test was initiated.

This battery indicator is used as the electronic witness that the MOB1 has been activated.

Green / Amber Indicator. <i>Changes to Amber after 1 hour of use</i>		Red indicator status
No of Flashes	No of Hours Used	Type of Failure
1 Flash	0 to 1hr (Green)	
	1 to 2hrs (Amber)	
2 Flashes	2 to 4hrs (Amber)	Frequency generation
3 Flashes	4 to 6hrs (Amber)	Transmit Power
4 Flashes	6 to 8hrs (Amber)	Battery failed
5 Flashes	8 to 10hrs (Amber)	No GPS Fix
6 Flashes	Over 10hrs (Amber)	



**Table 1: Pass/Fail indication**



The amber test result indicates the battery has been used for over one hour or the allowed number of tests has been exceeded. The MOB1 will still operate normally in distress, but the battery should be replaced immediately to ensure the full operating life when your MOB1 is needed.

## 6.2 DSC Transmission Test



To initiate a DSC test transmission, press and hold the TEST/OFF Key. The red LED will start flashing, then after five seconds become steady. Release the TEST/OFF Key. After a short pause a DSC Routine call to your vessel's DSC VHF will be transmitted. The strobe will flash and the indicator LED will flash green or amber to show a pass or red to show fail status, as indicated in Table 1. The MOB1 will then automatically turn off.

-  The DSC test requires that a valid MMSI has been programmed into the MOB1. See section 4 for instructions on programming the MMSI.
-  The DSC test should only be carried out a maximum of two times a year to minimise battery consumption.

## 6.3 AIS transmission test

To initiate an AIS transmission and GPS test, press and hold the TEST/OFF Key. The red LED will start flashing and then become steady after five seconds. After a further five seconds, the LED will start flashing slowly. Release the key. The LED will give a long red flash followed by a short green flash until GPS lock is achieved. After GPS lock is obtained, the MOB1 will transmit a single burst of AIS messages indicated by eight short flashes of the green LED. The strobe will flash and the indicator LED will flash green or amber to show a pass or red to show fail status, as indicated in Table 1. The MOB1 will then automatically turn off.

After a successful test, the message "MOB1 TEST" will be displayed on a suitable AIS receiver or plotter display.

-  The AIS/GPS test should only be attempted with a clear view of the sky.
-  The AIS/GPS test should only be carried out a maximum of three times a year to minimise battery consumption.

## 7. APPENDIX

### 7.1 Maintenance and Troubleshooting

Your MOB1 will require little maintenance except periodic cleaning, if required. Always use a damp cloth to clean the case and dry thoroughly. Do not use solvents or other cleaning fluids as this may cause the plastics to deteriorate. Ensure the antenna is free to unwind.

### 7.2 Batteries

The MOB1 contains Lithium metal batteries for long operating life. Your battery must be replaced either prior to the expiry date or after the MOB1 has been used, even if only activated for a short period of time. Battery replacement must be carried out at an Ocean Signal authorised battery replacement centre.

### 7.3 Transport

When shipping your MOB1 the following guidance and regulations should be followed, but you are advised to contact your nearest battery replacement centre or Ocean Signal prior to shipping as regulations may have changed.

- Always pack your MOB1 securely in a stout cardboard carton. Ocean Signal advises that you keep the original packaging in case of return for service.
- For surface transport the MOB1 may be shipped under special provision 188.
- For air transport the MOB1 should be shipped as category UN3091 and packed under IATA packing instruction 970 section II. If you are hand carrying your MOB1 on an aircraft please contact your airline for advice.
- Consult the manufacturer's instructions for information on carrying a life jacket in your luggage on board aircraft.

### 7.4 Disposal

Care should be taken when disposing of your MOB1 when it is no longer required. It is recommended to remove the battery from the MOB1 by removing the case lid. The case screws are covered by the top label. Dispose of the battery in accordance with local waste regulations. **Please note that the MOB1 is not user serviceable and opening the case will invalidate the warranty.**

### 7.5 Licensing (US only)

Under the rules of 47 C.F.R Part 95, licensing or registration of MSLD devices is not required. MSLDs are not authorised to be used on Land.

## 7.6 Specifications

### AIS transmission

Transmit Power (EIRP) .....	1Watt
Frequency .....	161.975/162.025MHz ±500Hz
Baud rate.....	9600baud
Synchronisation .....	UTC
Messages .....	Message 1 (Position), Message 14 (MOB status)
Repetition interval.....	8 messages/minute
.....	Message 14 sent twice every 4 minutes

### DSC Transmission<sup>1</sup>

Transmit Power (EIRP) .....	0.5Watt
Frequency .....	156.525MHz
Messages .....	Individual Distress Relay* All Ships Distress Alert* <sup>1</sup>
Message repetition .....	Once every 5 minutes (Relay only)
Baud rate.....	1200baud

\*Single call made on press of the activation button, in regions where it is allowed.

### Battery

Operating lifetime .....	>12hours @ -20°C (>24hours typical)
Storage life.....	7 years

### Environmental

Temperature range (operational).....	-20°C - +55°C
Temperature range (storage).....	-30°C -+70°C
Damp Heat (humidity).....	40°C at 93%
Drop (hard surface).....	1m : 6 sides]
Designed to meet Drop (water).....	20m : 3sides
Water immersion.....	2 bar : >60minutes
Thermal Shock.....	45° into 100mm of water : >1hour

### Physical

Weight .....	92grams
Dimensions .....	134mm x 38mm x27mm
.....	59mm over bracket

<sup>1</sup> DSC functionality is subject to the regulations of the country.



## 7.7 Approvals

The MOB1 is approved for use in the USA under CFR47 part 95K, and approved in Canada with AIS only under RSS287.

### 7.7.1 European Declaration of Conformity

Hereby, Ocean Signal Ltd. declares that the radio equipment type rescueME MOB1 is in compliance with Directive 2014/53/EU.

See [http://oceansignal.com/wordpress/wp-content/uploads/MOB1\\_RED\\_DofC.pdf](http://oceansignal.com/wordpress/wp-content/uploads/MOB1_RED_DofC.pdf)



## 7.8 Country of Intended Use

Austria	✓	Germany	✓	Netherlands	✓
Belgium	✓	Greece	✓	Poland	✓
Bulgaria	✓	Hungary	✓	Portugal	✓
Cyprus	✓	Ireland	✓	Romania	✓
Czech Republic	✓	Italy	✓	Slovakia	✓
Denmark	✓	Latvia	✓	Slovenia	✓
Estonia	✓	Lithuania	✓	Spain	✓
Finland	✓	Luxembourg	✓	Sweden	✓
France	✓	Malta	✓	United Kingdom	✓

The Country of Intended Use Table is an EU requirement only

## 7.9 Limited Warranty

Your Ocean Signal MOB1 is warranted against manufacturing defects in materials and workmanship for a period of 5 years from the date of purchase and in accordance with the following conditions.

Ocean Signal will at its discretion, repair or replace faulty product free of charge excluding the cost of shipping. Proof of purchase shall be required in order for a warranty claim to be valid from the original purchaser. All claims shall be made in writing to Ocean Signal or an approved service dealer or distributor.

Ocean Signal shall not be liable to the buyer under the above warranty:

- for any repairs or modifications carried out on the MOB1 using parts that are not supplied or approved by the manufacturer Ocean Signal including batteries and for work carried out other than by Ocean Signal or approved service dealers,
- for any part, material or accessory that is not manufactured by Ocean Signal the consumer will be covered by the guarantee / warranty offered to Ocean Signal by the manufacturer or supplier of such a component,
- for product which has not been fully paid for,
- for any product supplied by Ocean Signal to a customer under an alternative warranty or commercial agreement,
- for the cost of shipping product to and from the customer.

The Battery is only warranted until the date of expiry and provided the unit is tested in accordance with the information in the user manual. This warranty does not apply to a used battery as indicated by the electronic witness (see section 6.1).

The following specific item is excluded from this warranty:

- Damage to the antenna

This warranty does not affect your statutory rights. This warranty is to be interpreted under English law.

For further assistance please contact our Technical Service Department.

Email: [service@oceansignal.com](mailto:service@oceansignal.com)



Ocean Signal Ltd.  
Unit 4, Ocivan Way  
Margate  
CT9 4NN  
United Kingdom

[info@oceansignal.com](mailto:info@oceansignal.com)  
[www.oceansignal.com](http://www.oceansignal.com)

